

THIS IS RKB



RKB
BEARING INDUSTRIES
SWITZERLAND





Publication **TIRKB.Rev05EN**

© RKB Europe SA

Every care has been taken to ensure the accuracy of the information in the present document but no liability can be accepted for any errors, omissions, losses and damages (direct, indirect, consequential).

Reproduction in whole or in part without our authorization is prohibited.

Table of Contents

RKB Group

- **SWISS PREMIUM CLASS**
 - RKB Group Milestones
 - RKB: the Swiss Premium Class Bearing Manufacturer
- **WORLD PRESENCE**
 - RKB Main Sites
 - RKB Partner Network
- **INDUSTRIAL EXPERIENCE**
 - Deep Knowledge of All Major Industries
 - A Unique Source for Industrial Bearings



Production

- **A MATTER OF STEEL**
 - A Full Range of Bearings With a Focus on Large Sizes
 - Only Premium Quality Steels
 - Leading-Edge Heat Treatments
- **MANUFACTURING TECHNOLOGY**
 - Advanced Technology with a Focus on Flexibility
 - Latest Technology for Medium and Large Size Bearings
 - Automation for Small Sizes
- **QUALITY PROGRAM**
 - Organizational Efficiency and Flawless Production
 - Certified Metrology and Metallographic Laboratories
 - R&D Meets Production Needs



Service

- **ENGINEERING & ASSISTANCE**
 - Complete Engineering Support
 - Root Cause Failure Analysis
 - Assistance at Customer's Site
 - Training and Seminars
- **SPECIAL PROJECTS**
 - Special Solutions for Special Applications
- **JUST IN TIME**
 - Huge Stock of Standard and Special Bearings
 - Strong Brand Identity
 - Global Logistics Network



Product Table



FAQ





1936

1960

1978

1996

2001

2007

2014

2016

2018

2020

2022



RKB: the Swiss Premium Class Bearing Manufacturer

The RKB Bearing Industries Group is the Swiss manufacturing organization which has been operating in the bearing industry since 1936, with a monthly production capacity exceeding 350 tons of machined steel.

The experience gained over the years provides RKB with the know-how and expertise necessary for the development and manufacture of technological industrial bearings over 2.000 mm outer diameter.

RKB offers reliable cost-effective solutions, with extreme operational **flexibility**, leading-edge **service**, huge **stock** availability, **short delivery** time and the typical **quality** of a consistent premium-class bearing source.

With a worldwide distribution network and exports to more than 50 countries, RKB is globally recognized as *“The Alternative Power”* in the bearing industry.

RKB Group Milestones

RKB traces its roots back to the passion and commitment of the Colleoni family to building a reliable source for high quality rolling bearings and bushings for industry

The economic boom of 1960's led Mr. Gianni Colleoni to establish a new and modern facility of 9.000 sqm to **expand operations**

RKB starts a close cooperation with technological partners to exchange manufacturing expertise in **overseas projects**

RKB embraces the new challenges of the global economy by establishing the **RKB Group** along with a bunch of branch offices in the world

RKB management establishes two new production facilities: **RKB LN Plant** and **RKB MS Plant**

RKB T3 Plant celebrates official opening, encompassing an area of 56.000 sqm

RKB acquires 40.000 sqm of new property for the new **T4 Plant**. RKB MS Plant relocates to a new site of 8.000 sqm

RKB opens two new branch offices: **RKB SSC** in Romania and **RKB Latam** in Mexico

RKB opens a new branch office in Canada with adjoining warehouse

RKB starts **RKB MENA** with bearing stock to serve UAE and adjacent countries

RKB establishes **RKB Wälzlager GmbH**, a new local branch located in Oer-Erkenschwick, Germany

SWISS PREMIUM CLASS

WORLD PRESENCE

INDUSTRIAL EXPERIENCE



RKB GROUP



SWISS PREMIUM CLASS

WORLD PRESENCE

INDUSTRIAL EXPERIENCE

● Europe

- | | |
|------------------------|--------------------|
| Austria | Poland |
| Belgium | Portugal |
| Bosnia and Herzegovina | Republic of Kosovo |
| Bulgaria | Romania |
| Croatia | Serbia |
| Czech Republic | Slovenia |
| France | Spain |
| Germany | Sweden |
| Italy | Switzerland |
| Kazakhstan | The Netherlands |
| Lithuania | Turkey |
| Luxemburg | Ukraine |
| Macedonia | United Kindom |

● America

- | | |
|------------|----------------------|
| Argentina | Mexico |
| Bolivia | Panamà |
| Brazil | Paraguay |
| Canada | Peru |
| Chile | Puerto Rico |
| Colombia | República Dominicana |
| Costa Rica | Uruguay |
| Cuba | USA |
| Ecuador | Venezuela |
| Guatemala | |

Partner

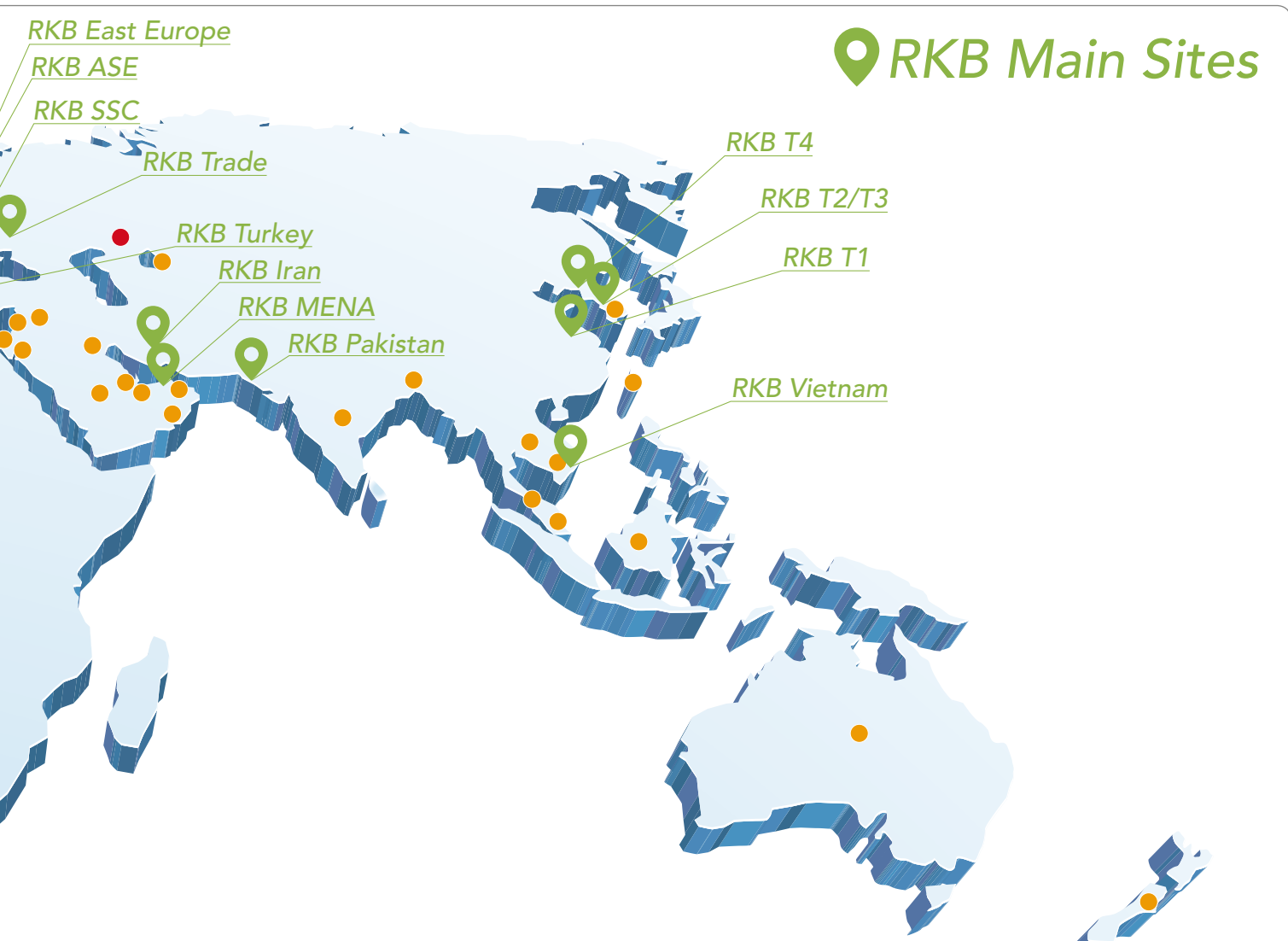

Network

- Africa
 - Egypt
 - Morocco
 - South Africa
 - Tunisia

- Asia-Pacific
 - Australia
 - Bangladesh
 - India
 - Indonesia
 - Iran
 - Israel
 - Jordan
 - Kindom of Bahrain
 - Kuwait
 - Lebanon
 - New Zealand

- Oman
- Pakistan
- Qatar
- Saudi Arabia
- Singapore
- South Korea
- Syria
- United Arab Emirates
- Uzbekistan
- Vietnam



Deep Knowledge of All Major Industries

Born as a niche supplier of rolling bearings and bushings, at present the RKB Group serves a full range of industries all around the world, having developed specific knowledge and expertise in each of them. Understanding the unique attributes and requirements of every industry is at the base of RKB's manufacturing and marketing philosophies.

After thousands of successful cases of collaboration with leading OEM and MRO customers in different fields, RKB has gained an unparalleled bearing knowledge.

From shipbuilding to offshore oil platforms, from steelmaking to metalworking, from excavators to tunnel boring machines, from lifting bridges to power transmission applications, from home appliances to giant gearboxes for wind turbines, from heavy automotive to off-highway applications, RKB can point to a history of real gains in all major industries.

Thorough understanding and first-hand experience in designing, R&D, and manufacturing technology are at the base of RKB's success in every industrial sector.



% Turnover

4%
Angular
contact ball
bearings



6%
Deep
groove ball
bearings



14%
Tapered
roller
bearings



15%
TQO



34%
Spherical
roller
bearings



17%
Cylindrical
roller
bearings



10%
Multiroll

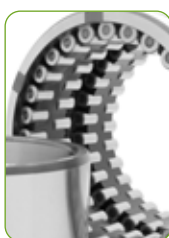



16%
Power transmission



11%
Marine, shipyard and offshore



6%
Electric motors, industrial fans and pumps



6%
Pulp and paper, converting and printing

% Turnover

7%
Renewable and traditional energy



5%
Chemicals, plastics and rubber



16%
Mines and minerals



28%
Metals



5%
Off-highway



SWISS PREMIUM CLASS

WORLD PRESENCE

INDUSTRIAL EXPERIENCE

A Unique Source for Industrial Bearings

RKB always specialized in designing and manufacturing all types of rolling bearings:

- Deep groove (DGBBs) and angular contact ball bearings (ACBBs)
- Spherical roller bearings (SRBs), which are the largest share of the current production
- Cylindrical roller bearings (CRBs), particularly multiroll assemblies
- Tapered roller bearings (TRBs), especially multi row arrangements

The challenge of RKB is to offer, as a unique and **reliable source**, a **complete portfolio** of innovative high quality rolling bearings, ranging from miniature to extra-large sizes. RKB rolling bearings are manufactured in **conformity with ISO, ANSI/ABMA or GOST** standards or according to customer's special requirements. Naturally, customers are supported by RKB's Technical Department in the selection process of the most adequate bearing for their specific applications.

PRODUCTION

A Full Range of Bearings With a Focus on Large Sizes

RKB presently engineers and produces over **8.000** different part numbers. They are commonly divided into four segments, according to bearing type and manufacturing site.

T1

Miniature and small size ball bearings manufactured in RKB MS Plant (8.000 sqm)

Size range: 1-35 mm bore diameter
Precision class: up to P4-ABEC 7



T2

Standard rolling bearings manufactured in RKB T3 Plant (56.000 sqm)

Size range: 40-2000 mm outer diameter
Precision class: up to P0/P6-CL4



T3

Technological and customized rolling bearings manufactured in RKB T3 Plant (56.000 sqm)

Size range: 80-1500 mm outer diameter
Precision class: up to P6/P5-CL2/CL3-HP



T4

Rolling bearings manufactured in large and repeated batches in RKB T4 Plant (40.000 sqm)

Size range: 300-600 mm outer diameter
Precision class: up to P6/P5-CL2/CL3-HP



A MATTER OF STEEL

MANUFACTURING TECHNOLOGY

QUALITY PROGRAM



Only Premium Quality Steels

High-quality bearings require **high-quality raw materials**. Steel cleanliness is the key element in choosing materials that can remarkably improve bearing fatigue performance and load carrying capacity. Based on a long collaboration with the most **renowned steelmakers worldwide**, RKB can currently rely on different types of steel (**5 through-hardening** and **2 case-hardening**), which are purposely selected according to bearing characteristics and application requirements.



5%

43%

43%

9%

% Volume



Leading-Edge Heat Treatments

RKB is at the forefront of heat treating processes. Its **specialists** can rely on automatic heat treatment lines, with multiple salt bath tanks and controlled atmosphere conditions for **bainite hardening treatment (HB)**, furnaces for dimensional stabilization and technology to reduce retained austenite and ensure smooth operation at below zero temperatures. All protocols are expressly studied to give the best hardenability or the most **uniform case layer depth (CHD)**.





Latest Technology for Medium and Large Size Bearings

RKB T3 Plant and T4 Plant, which together cover a total area of 96.000 sqm, are specifically dedicated to the production of **medium and large size bearings**, both standard and customized.

Among other things, they feature:

- over **260** machining centers
- latest generation multi-axis CNC lathes
- latest generation multi-axis CNC grinders
- high precision hard turning machine tools

to reach stricter bearing dimensional and geometrical parameters

- **high precision honing** machine tools to improve bearing form characteristics
- **special surface treatments** to extend bearing resistance to wear and corrosion (AWT and PT)
- **centralized digital traceability system** for collection of all manufacturing data.

Advanced Technology with a Focus on Flexibility

RKB's business model is based on the concept of a **vertically integrated system**, according to which all main phases of the production chain are managed within company perimeter. Through the **effective control** of every manufacturing step, RKB ensures the quality of its products.

RKB is continuously updating its production processes to optimize investments in equipment and to exploit the latest technical and engineering developments. RKB's manufacturing strategy is supported by the R&D Department, which constantly develops **new technologies and techniques** to increase product reliability, production flexibility and environmental sustainability.

RKB's innovative business model can respond quickly to all supply requests, even in small or medium batches.

Finally, the wide use of smart in-line systems for **tighter control of manufacturing processes** efficiently reduces waste and production allowances and variations, resulting in enhanced overall quality and precision.

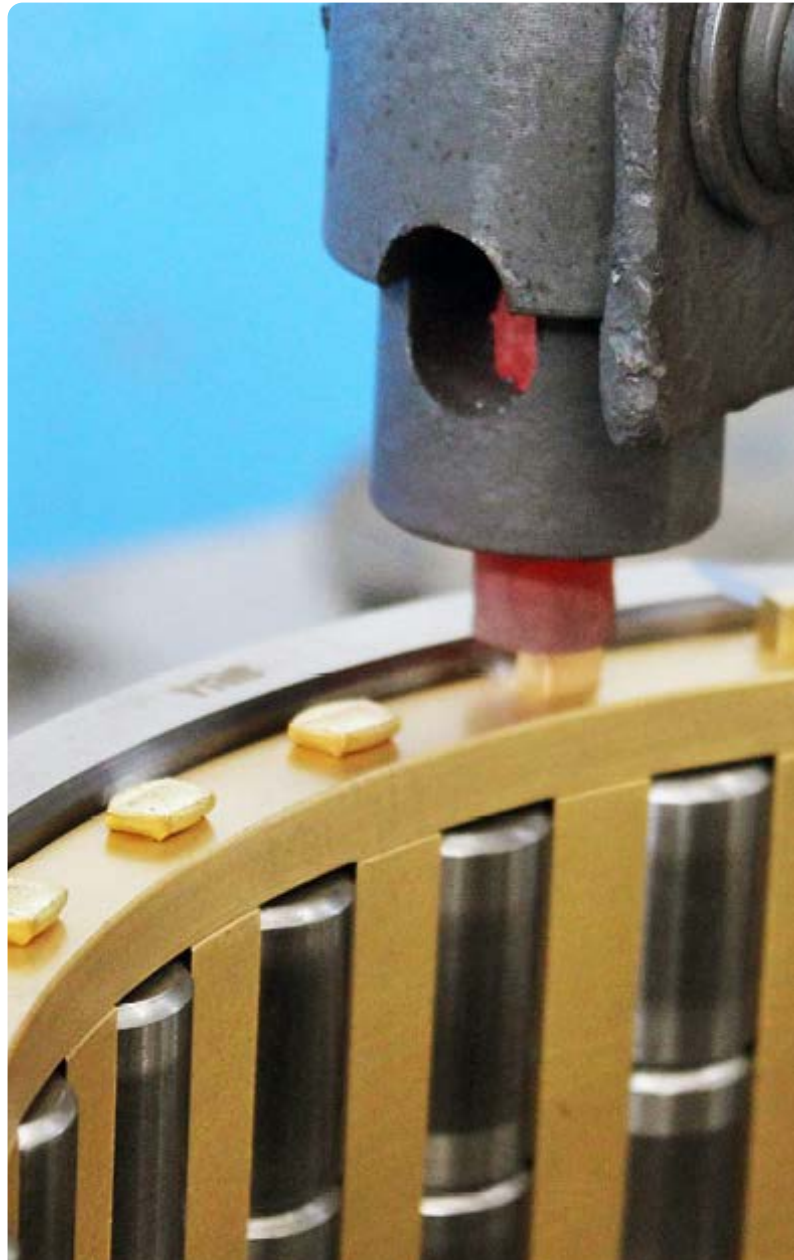

A MATTER OF STEEL

MANUFACTURING TECHNOLOGY

QUALITY PROGRAM



Automation for Small Sizes

RKB's new MS Plant encompasses over 8.000 sqm and is dedicated to manufacturing miniature and small size ball bearings:

- 36 fully automatic production lines
- strictly controlled environmental conditions of all workshops
- in-line Anderson meters for control of 100% output
- centralized digital traceability system for collection of all manufacturing data.

PRODUCTION



Organizational Efficiency and Flawless Production

Since its foundation, the RKB Group has been following a **Total Quality Approach** devoted to increasing organization efficiency and safeguarding product quality. RKB Executive Headquarters and manufacturing facilities have **ISO certifications** in quality, environment, and occupational health and safety, which are a mark of distinction and well emphasize the commitment of the Group to sustaining rigorous standards of quality throughout the value chain.

As an additional proof of this, in 2012 RKB was awarded **top class rating by D&B**, the world's leading source of commercial information and insight on businesses. In terms of production, RKB has developed a **multilevel quality control system** to prevent flaws from spreading in the production chain: from steel bar acceptance to forging, from turning to heat treatments, from grinding to assembling.

Naturally, together with the strict in-line controls directly carried out in RKB manufacturing facilities, further dimensional and destructive controls are methodically performed in the metallographic and metrological laboratories of the Group.

A MATTER OF STEEL

MANUFACTURING TECHNOLOGY

QUALITY PROGRAM

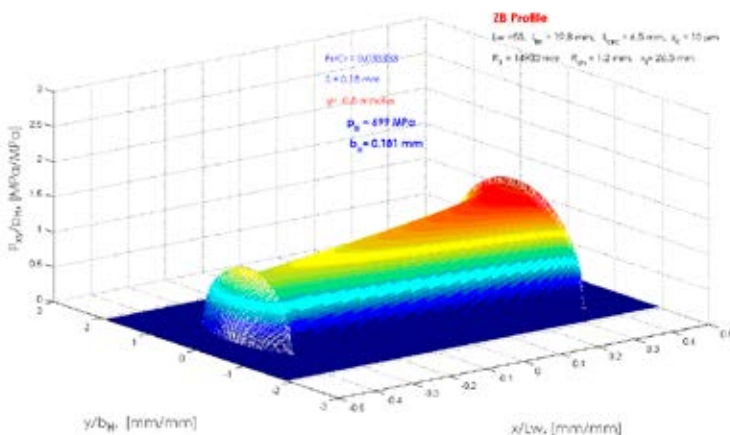

R&D Meets Production Needs

Every year the RKB Group invests more than **10% of total turnover for R&D**. The main target is to maximize product quality and performance, while reducing overall costs. The main activities of R&D involve:

- **advanced calculation tools** to predict actual contact areas, load and pressure distributions, and von Mises stresses
- **new materials** for rings, rollers and cages in direct collaboration with renowned steelmakers worldwide.

Certified Metrology and Metallographic Laboratories

All metrological and metallographic laboratories in RKB facilities and Headquarters serve the **Quality Assurance** of the Group, guaranteeing the consistency of the goods that are finally supplied to customers.

The **metrological laboratories** are equipped with **latest generation devices** for the measurement of raceway and roller profile, roughness, waviness, roundness and all other geometrical and form parameters that may affect bearing quality and therefore performance.

The same applies to the **metallographic and metallurgical laboratories**, where highly skilled and trained engineers use leading-edge equipment to perform all kinds of analyses, including micro-hardness test, evaluation of steel non-metallic inclusions, segregation and porosity, blue fracture test and many other analyses.



- **heat treatments** to increase bearing fatigue life by reaching optimal material microstructure
- **surface coatings** to reduce friction coefficient and increase wear and corrosion resistance
- **endurance tests** performed on special test rigs according to sudden death method
- **technical seminars** to transfer latest findings to design department
- **collaboration with academic centers** on tribology and bearing design.



Complete Engineering Support

Bearing Design

In order to optimize bearing performance, RKB makes extensive use of proprietary and commercial software systems, which strictly comply with the relevant international standards. Along with classic 2D drafting and 3D modeling tools for mechanical engineering, RKB can also count on a set of specifically developed **evolutionary algorithms for mono- and multi-objective optimal design** of bearing macro-geometry in order to maximize bearing life. Finally, finite element (FEM) and semi-analytical (SAM) methods are selectively used to refine design solutions through advanced simulations.



Co-Engineering Activities

Whether it is a greenfield project or an existing application, RKB's Technical Department can be actively involved to co-engineer and co-design with the customer's technical office. **Joint activities** mainly base on the chance of creating synergies between different domains of knowledge and expertise. In case of new applications, RKB can offer technical advice regarding:

- **selection** of bearing type, size, arrangement, fit with conjugate parts, internal clearance or preload, seals, and lubricant
- **calculation** of actual bearing loads, residual internal clearance or preload after mounting and in operation, bearing starting and operating torque, operating temperature, etc.

For machinery already in operation, RKB can provide value-added recommendations for:

- **lubrication** system and lubricants, in order to favor elastohydrodynamic conditions and decrease overall operating temperature
- **regreasing intervals** and grease amount to be used
- **bearing handling and maintenance.**



Root Cause Failure Analysis

RKB can perform a full bearing root cause failure analysis (RCFA) by which it's possible to:

- identify the **mechanisms** that caused the bearing to fail in a specific application
- assess bearing **steel cleanliness** for the eligibility process of steel suppliers
- analyze steel **microstructure and hardness** to validate heat treatment processes
- investigate **fracture nucleation and growth** using the latest optical microscopy techniques.

Assistance at Customer's Site

Application Engineering

RKB's Technical Team Unit (TTU) is the division of the Technical Department that offers **technical assistance** directly at customer's site. The Unit is made up of skilled application engineers and experienced mechanic assistants that feature:

- **bearing mounting supervision**
- **condition monitoring** services, including visual, shock and vibration analysis
- **training** with maintenance and technical staff, focusing on lubrication and correct mounting and dismounting procedures.

Reverse Engineering

Through the process of reverse engineering, RKB's Technical Team Unit can **deduce decisions from end products** in applications which have incomplete or obsolete documentation. The experience of RKB TTU is instrumental in solving **machine and bearing design problems** starting from little or no knowledge about the original components installed in the application. The analysis of the current mechanical design and operating conditions can also led to recommended **structural improvements**, optimizing the overall performance.

Asset Lifecycle Solutions

In today's business scenario, the effective management of assets throughout their lifecycle is crucial to deliver **value-added solutions**, improve productivity and reduce total costs. **BSS (Bearing Service and Solutions)** is the 360° proposal worked out by RKB to support customers over the entire lifecycle of the asset, from early consultancy services to after-sales maintenance. BSS aims to maximize the mechanical performance of the customer's application, creating **synergies** between RKB and the customer's knowledge and experience.



ENGINEERING & ASSISTANCE

SPECIAL PROJECTS

JUST IN TIME

Training and Seminars

Training is a cost-effective investment that yields **higher productivity and increased efficiency**. For this reason, RKB's Technical Department can offer a comprehensive and **customizable portfolio of seminars**, featuring highly skilled experts in the bearing industry.

The attendees of the training courses, which may take place both in RKB Headquarters and at the customer's plant, will increase their **knowledge** on the most significant bearing-related topics, thus improving their working efficacy.



SERVICE

Bearings for Gyrofin Stabilizer Systems

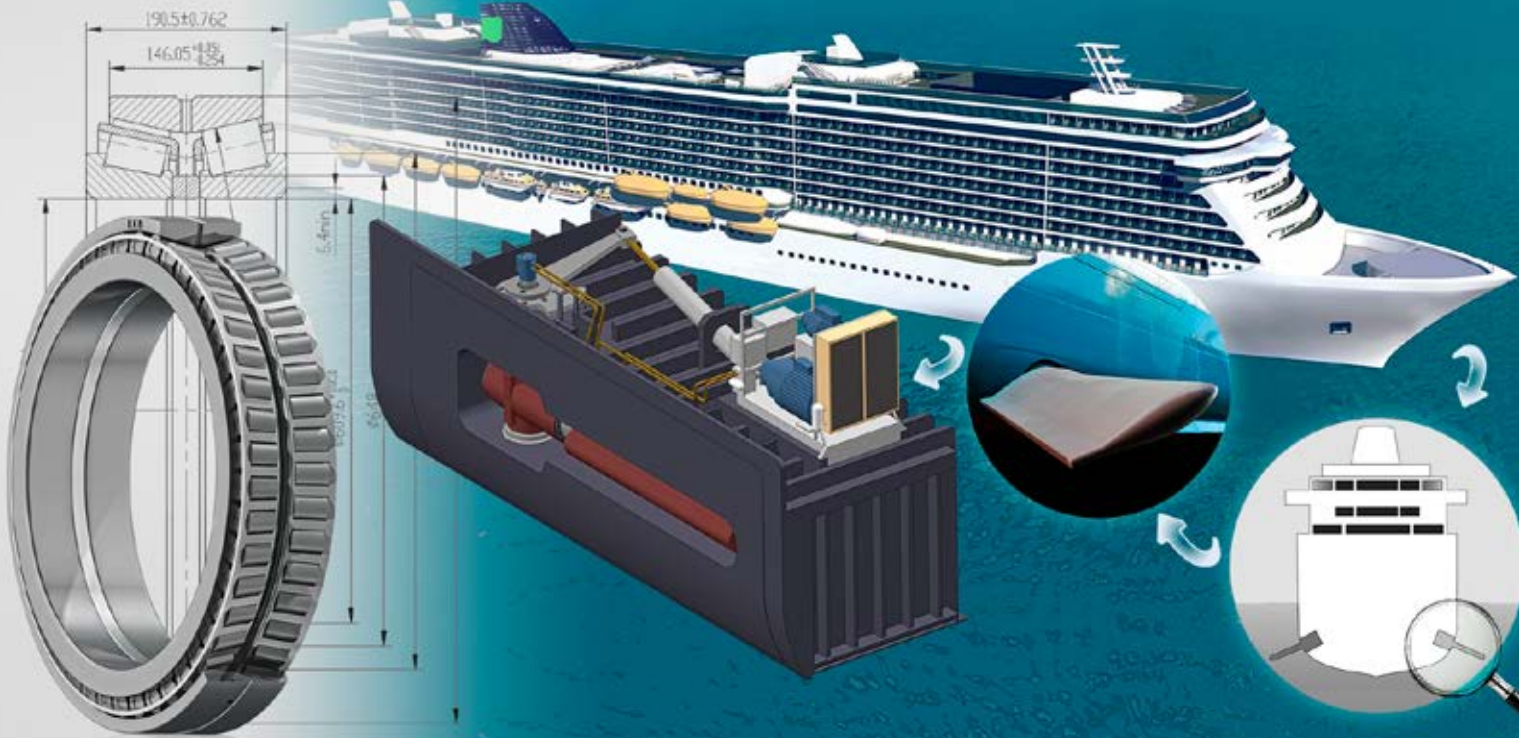

ENGINEERING & ASSISTANCE

SPECIAL PROJECTS

JUST IN TIME

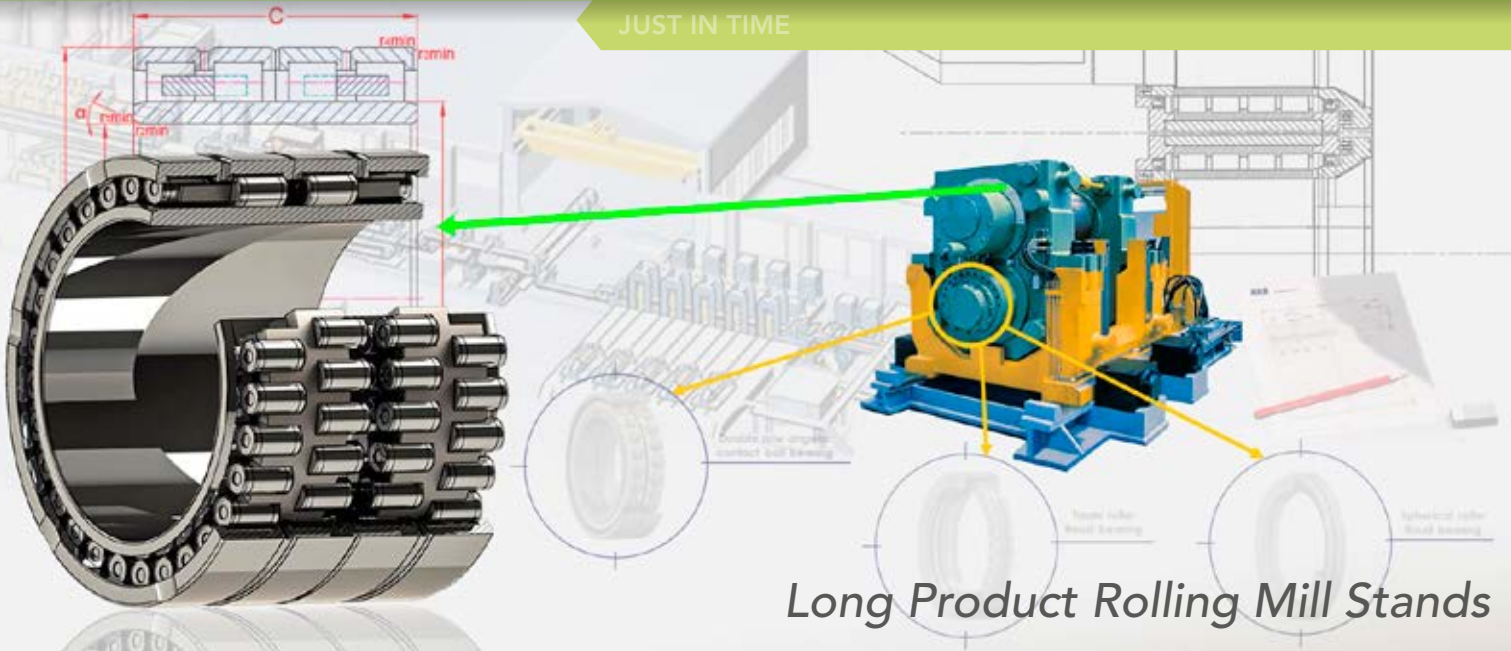

Long Product Rolling Mill Stands

Special Solutions for Special Applications

RKB is actively engaged in the development, management and oversight of hundreds of special projects worldwide to support clients in the implementation of **original and customized bearing solutions** for their applications.

Collaborating with OEM and MRO companies, RKB can develop the best technical proposals in order to **meet customer requirements** in terms of specifications and rolling bearing performance.



Jacking System in Offshore Platforms



Vertical Lifting Systems for Bridge

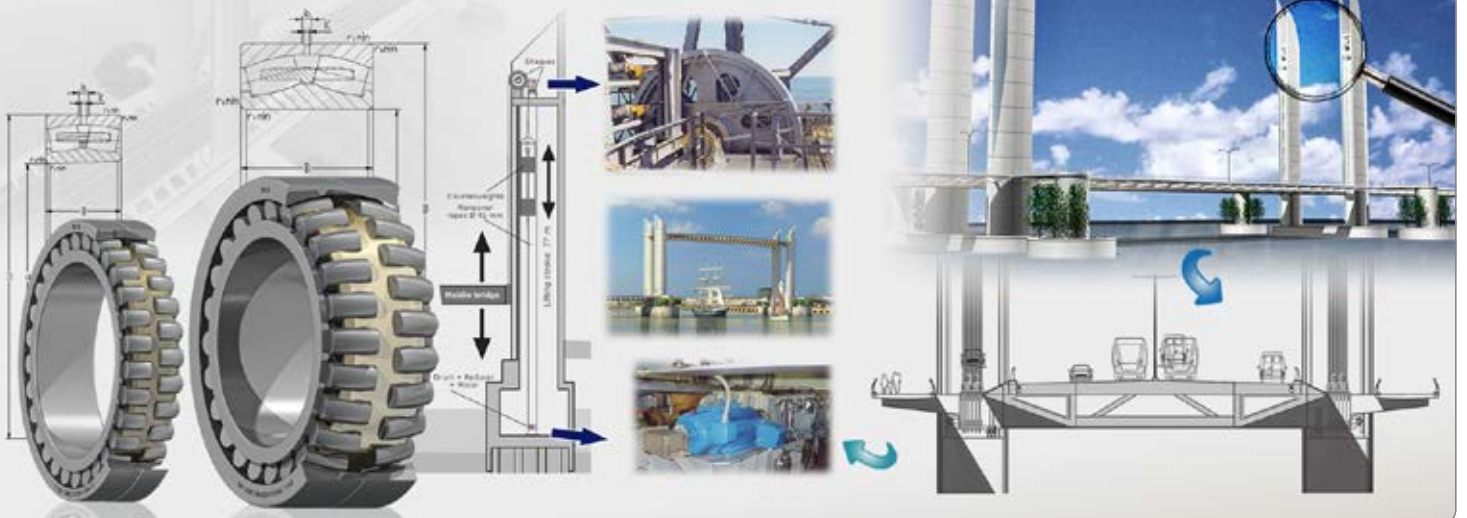

SERVICE

Front and Rear Axles of Dump Trucks

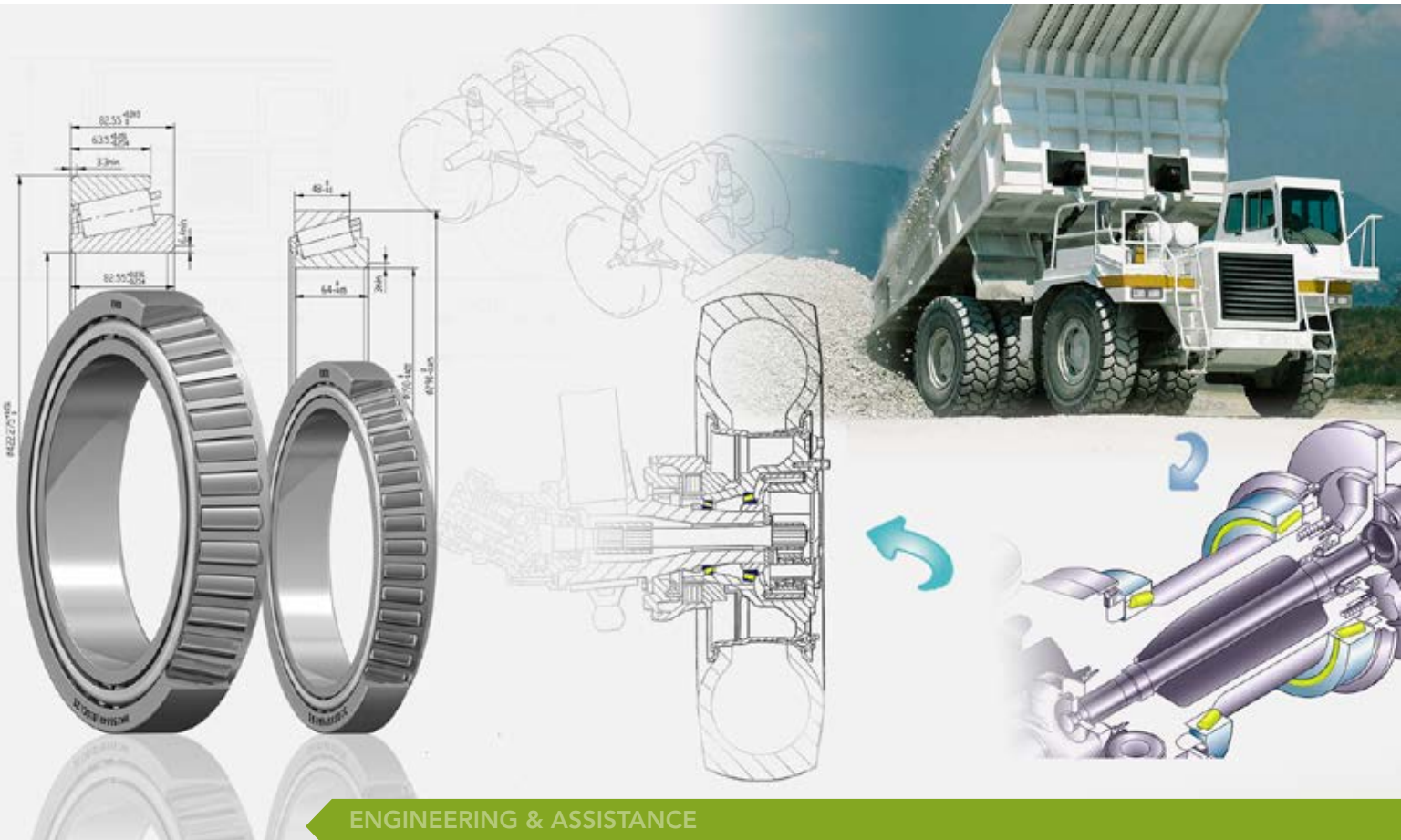

ENGINEERING & ASSISTANCE

SPECIAL PROJECTS

JUST IN TIME

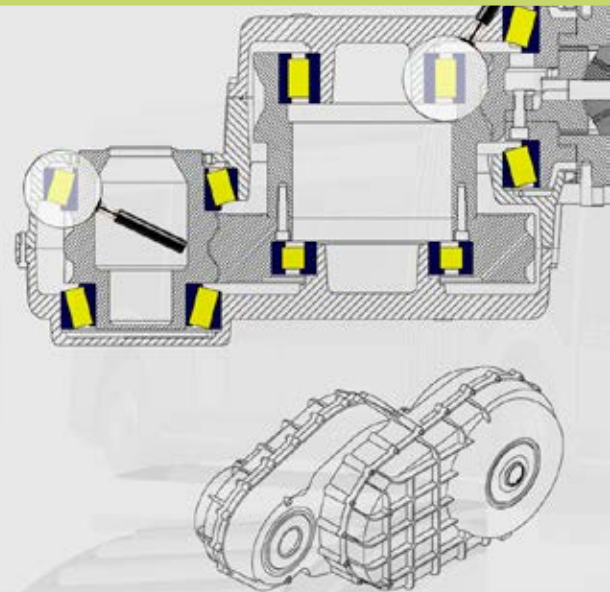

Gearbox for the City Bus on Tyres

Huge Stock of Standard and Special Bearings

RKB believes that stock availability is a crucial function for a world class bearing manufacturer's consistency, market presence and brand awareness.

The RKB Group has one of the **largest stocks** of rolling bearings worldwide. With over **9.000 part numbers** ranging from small to extra-large sizes, the current stock reflects the long standing experience and international vocation of RKB to support customers in a variety of industries worldwide.

Naturally, besides a well-stocked warehouse in terms of bearing **variety and availability**, a strong logistics organization is strictly necessary to efficiently serve the international market.

For this reason, all RKB stocks around the world are run by a proprietary software system (**ASSM - Active Stock System Management**) that optimizes lead time and drastically decreases machine downtime for the customer.



Strong Brand Identity

RKB has an ever growing **network of local warehouses** directly run in cooperation with its regional partners to ensure proximity and fast delivery. Naturally, all storage areas are under controlled environmental conditions to guarantee **perfect conservation of the bearings**.

Besides, RKB's highly specialized packaging, specifically created to protect the bearings in unfavorable conditions, is easily recognized and ensures **brand identity all over the world**.



Finally, RKB's stock strategy features the "JIT Bundle" which supports a special form of in-house consignment stock program to ease the customer's financial position and ensure availability of requisite spare parts based on a partnership approach.



ENGINEERING & ASSISTANCE

SPECIAL PROJECTS

JUST IN TIME

Global Logistics Network

The RKB Group can rely on a series of modern logistics hubs in the world's most strategic areas:

- **Switzerland** central hub: 15.000 sqm to deliver bearings to overseas countries
- **Italy** hub: 16.500 sqm to deliver bearings to European Union and Turkey
- **Romania** hub: 2.500 sqm to deliver bearings to East Europe
- **America** hubs: 5.000 sqm to deliver bearings to North, Central and Latin America
- **Middle east** hubs: 500 sqm to deliver bearings to UAE and adjacent countries



PRODUCT TABLE

Cylindrical Roller Bearings

O.D. up to 1800 mm

Single Row
Cylindrical
Roller Bearings

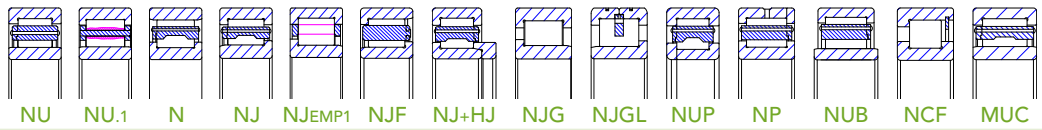

O.D. up to 1800 mm

Double Row
Cylindrical
Roller Bearings

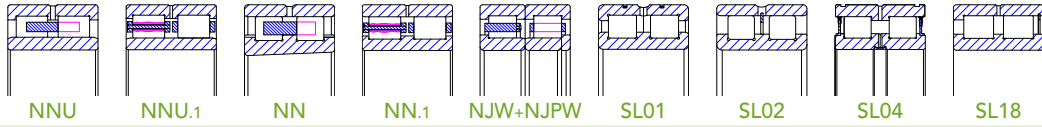

O.D. up to 1400 mm

Multi Row
Cylindrical
Roller Bearings

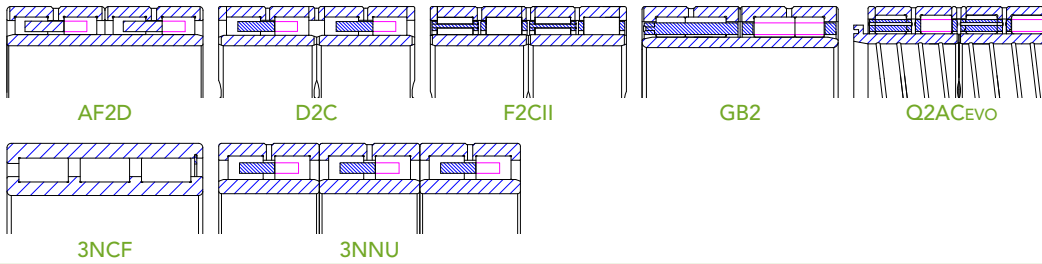

O.D. up to 1600 mm

Single Direction
Cylindrical Roller
Thrust Bearings

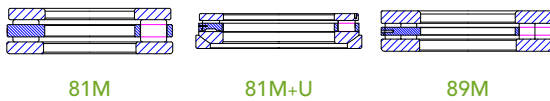

Double Direction
Cylindrical Roller
Thrust Bearings

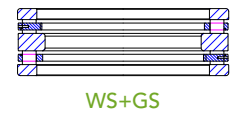

Tapered Roller Bearings

O.D. up to 1800 mm

Single Row
Tapered
Roller Bearings

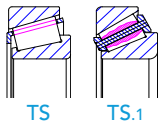

Single Row Paired
Tapered
Roller Bearings

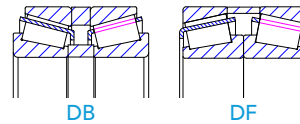

O.D. up to 1925 mm

Double Row
Tapered
Roller Bearings

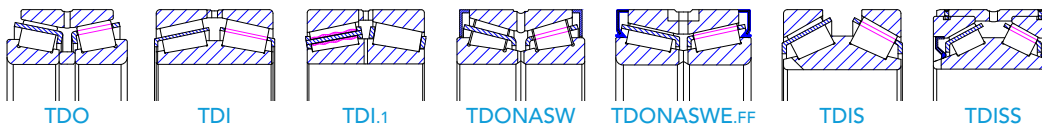

O.D. up to 1925 mm

Multi Row
Tapered
Roller Bearings

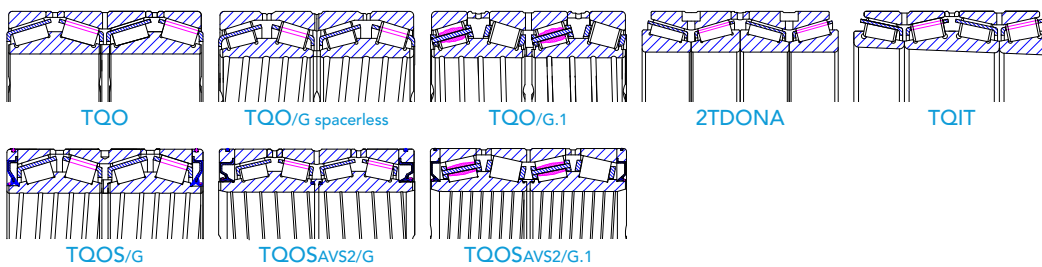

O.D. up to 1600 mm

Single Direction
Tapered Roller
Thrust Bearings

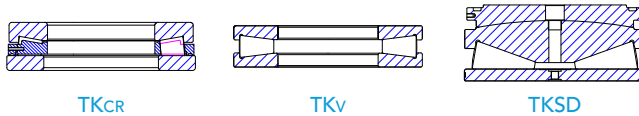

O.D. up to 1600 mm

Double Direction
Tapered Roller
Thrust Bearings

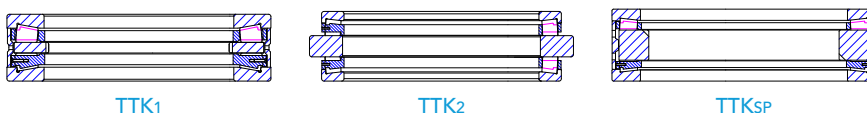

RADIAL

AXIAL

RADIAL

AXIAL

CYLINDRICAL ROLLERS

TAPERED ROLLERS

Ball Bearings

O.D. up to 1900 mm

Single Row
Deep Groove
Ball Bearings

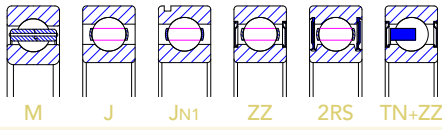

Single Row
Angular Contact
Ball Bearings

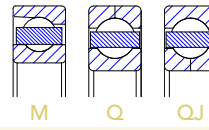

O.D. up to 1925 mm

Single Row Paired
Angular Contact
Ball Bearings

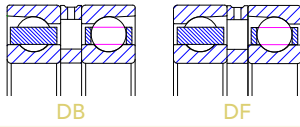

Double Row
Angular Contact
Ball Bearings

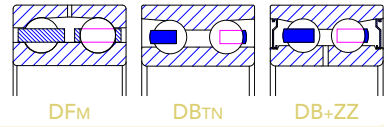

O.D. up to 1600 mm

Single Direction
Thrust
Ball Bearings

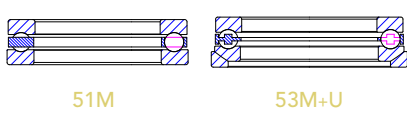

Double Direction
Thrust
Ball Bearings

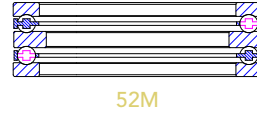

Spherical Roller Bearings

O.D. up to 1580 mm

Spherical
Roller Bearings

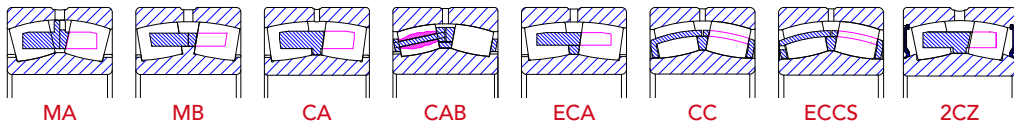

O.D. up to 1400 mm

Toroidal
Roller Bearings

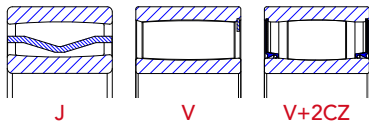

O.D. up to 1400 mm

Spherical Roller
Thrust Bearings

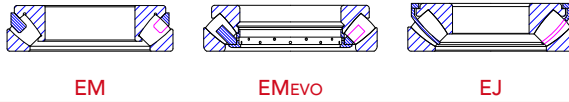

Other Products

O.D. up to 400 mm

Track and Needle
Roller Bearings

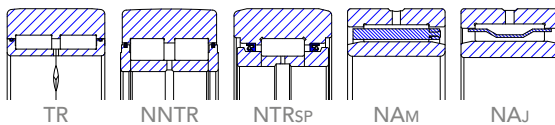

O.D. up to 1800 mm

Special and Split
Roller Bearings

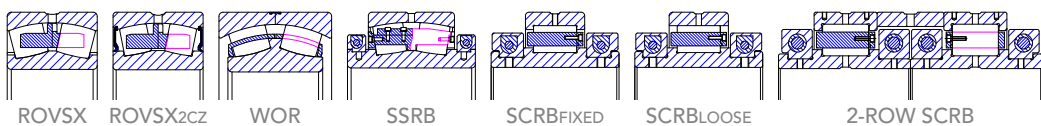

Slewing
Bearings

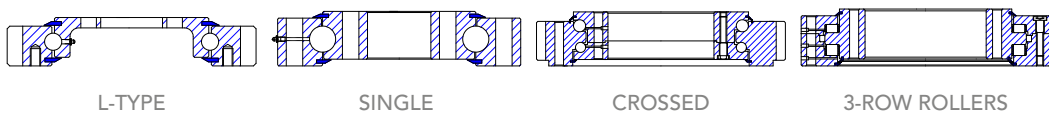

Notes

1. Bearing dimensional and running accuracy according to ISO/AFBMA/GOST standards
2. All bearings available in metric and inch sizes, with cylindrical or tapered bore
3. Special features available on request

Q1: What's the positioning of RKB in the bearing industry?

A1: The RKB Group holds a leading position in delivering premium rolling bearing solutions to empower the global industry.

RKB is headquartered in Switzerland and its origins date back to 1936, when we started as a local bushing maker.

At present, we manufacture a wide assortment of industrial rolling bearings, with a catalogue that boasts over 12.000 part numbers, from miniature ball bearings to standard and application-optimized technological products up to over 2.000 mm outer diameter.

RKB serves a full range of industries all around the world, having developed specific knowledge and expertise in each of them, and operating one of the largest stocks in Europe.

Besides product availability, RKB also offers a wide array of technical services to support customers over the entire life cycle of their assets, from early consulting projects to after-sales maintenance.

Unlike the other major brands, that adopt a global top-down approach and cover every inch of a territory, RKB is more customer-based and segment-oriented. This bottom-up style of RKB is based on focused actions and delivers equivalent and comparable results for the customer.

Q2: What are the most important markets for RKB?

A2: From a geographical point of view, Europe is RKB's main market. Within Europe, Italy, followed by Germany, France and Spain, play the most important role.

In the last two decades, we recorded a very positive and organic sales trend in America (North, Central and Latin), middle East, Africa, CIS and Asia-Pacific.

In terms of segments, the most relevant markets for RKB are represented by the following industries:

- metals
- mines and mineral
- power transmission

Other significant sectors for RKB are:

- marine and shipyard
- pulp and paper, converting and printing
- traditional and renewable energy
- electric motors
- fluid power
- chemical, plastics and rubber

Q3: Is RKB able to supply its bearings worldwide?

A3: RKB believes that stock availability is a crucial function for the consistency, market presence and brand awareness of a world-class bearing manufacturer. For this reason, we can rely on a network of modern hubs and local branches in the world's most strategic areas.

We operate in over 50 countries and a strong logistics organization is strictly necessary to efficiently serve the global market.

RKB stock strategy also features a special form of consignment stock to ease the customer's financial position and ensure availability of requisite spare parts based on a partnership approach.

Q4: What's the origin of RKB bearings?

A4: The topic of origin is a quite complex issue from a legal and customs point of view.

RKB is headquartered in Switzerland and therefore follows the Swiss regulations to determine the country of origin of its products.

Most of our bearings can be considered of "Swiss origin" according to the criterion B of the applicable Swiss laws. This criterion implies that more than 50% of the costs to produce the bearings are generated in Switzerland. If this condition is not satisfied, the origin must be considered as "non preferential" (criterion E).

Beyond these technical aspects, the important thing is that our bearings are all made to the same specifications and always within our properties and under our control and authority, irrespective the geographical location of the plant.

To achieve the optimization of resource allocation, all the global bearing makers, including RKB, have processing plants also in China. These plants exclusively produce for us, respecting the high-quality European standards we impose, and the best practices developed in the bearing industry worldwide.

Keep in mind that RKB is a genuine manufacturer and not an intermediary or a trader.

Q5: There are many bearing suppliers and brands on the market, why should we choose RKB?

A5: Like all the major brands do, also RKB meets the fundamental characteristics of a leading bearing maker:

- cutting-edge production technology
- technical know-how and expertise

- full range assortment of top-quality industrial rolling bearings
 - corporate stability and tradition
- R&D and well-equipped laboratories for metrological, metallographic and metallurgical analyses

At the same time, the compact size of RKB generates remarkable advantages in terms of:

- flexibility and quick decision-making
- privileged relationship with customers
- capital-intensive stock of products (valued around \$120 million)
- comprehensive technical assistance in a single place, from early consulting to RCFA
- excellent value for money
- product liability insurance

Q6: How does RKB stand towards the cheap products, especially when it comes to approaching the price-oriented customers?

A6: RKB business model was not intended to compete with the manufacturers of poor bearings, many of which are merely traders of sub-standard products.

The shortcomings of these cheap manufacturers are especially noticeable in terms of design, raw material, finishing, performance and safety.

Based on our experience, a price-oriented choice is synonymous with a series of hidden additional costs for the customer.

RKB aims to create a long-term relationship with its customers and this can only be achieved by providing high-quality bearings and services over time.

Q7: How are we supposed to convince our technical department to install RKB bearings in high-criticality applications if they don't have any previous experience with this brand?

A7: RKB has always had a strong focus on the heavy machinery for the steel, mining and power transmission industries. Since our founding, we have constantly worked to provide valuable solutions for the most demanding applications.

We daily cooperate with OEM and MRO customers to design and select the most appropriate technological bearings for their equipment.

Over the decades, RKB has established a long track record of successful cases in many different applications and markets: this is the basis to gain the confidence and trust of skeptical technicians.

RKB is also available to submit its own products to a testing and homologation process by the customer to assure that they meet all the relevant standards. The performance and outcome will be monitored and evaluated together with the client.

Q8: What kind of technical support is RKB able to provide to its customers?

A8: RKB offers to its customers assistance and advisory services at each phase of the asset life cycle, from bearing design and selection to technical recommendations for equipment already in operation.

We can provide support in terms of:

- 2D and 3D bearing design and modeling
- FEM and SAM analysis
- co-engineering and co-design with customer's technical office
- reverse engineering
- bearing selection
- bearing advanced calculations
- recommendations for lubrication, handling and maintenance
- bearing mounting supervision
- condition monitoring, including visual, shock and vibration analysis
- highly specialized laboratories for technical expertise and RCFA
- training with customer's maintenance and technical staff

Q9: The RKB brand is not widely present in the market. What actions are you going to take to increase your brand awareness?

A9: The topic of brand awareness and reputation is very important to us, especially in those markets where RKB doesn't have a long history of being present.

We are strongly committed to investing important resources to increase our brand awareness across the world, in particular through:

- participation in local exhibitions worldwide
- creation of a corporate website full of useful tools and information
- constant production and rollout of paper and digital marketing literature
- distribution of branded gadgets and banners, flags, stickers etc. within the sales network
- international advertising campaigns on digital media and industry magazines
- development of a corporate application for mobiles (iOS and Android) to keep our network up-to-date about the latest news of the Group

RKB

BEARING INDUSTRIES
SWITZERLAND

Via Primo Agosto 1 · 6828 Balerna · Switzerland
P.O. Box 16 · 6830 Chiasso 3 · Switzerland
Phone +41 91 260 09 30 · Fax +41 91 260 09 50
info@rkbeurope.com · www.rkbbearings.com

TOGETHER WE ARE WORTH MORE!

